

## Product Information

The Lowbay.4 LED fixture is a low profile, surface mounted indoor LED lighting solution.

This LED fixture features polycarbonate housing with a durable white enamel finish

The Lowbay.4 is perfect for Educational Facilities, Office Buildings, Parking Garages and a variety of other indoor lighting applications.

## Performance Ratings and Certifications

UL 1598  
UL 8750  
CSA C22.2#250.0  
CSA C22.2#250.1  
IP Rating: IP65  
NSF Certified

## Performance Summary

Lumens: 5,557 lm – 19,448 lm  
Lumens Per Watt (typ.): 139.97 – 140.01  
Power Consumption: 39.7 – 138.9 W  
Light Engine: L70 Rated Lifetime of 100,000+ hours.  
CRI: Minimum 70 CRI. Optional custom CRI.  
CCT (Typical): 3000K, 4000K, 5700K, optional tight bins.  
Light Dist. Pattern: Multiple distribution patterns available.  
Manufactured in the U.S. with parts from U.S. and imported.

## Fixture Information

Housing: Polycarbonate  
Color: White. Custom color also available.  
Finish: Superior dual coat finish. Chemical resistant epoxy primer and/or Marine Grade coating optional.  
Lens: Frosted Polycarbonate. Clear optional.  
Mounting: Surface. Bracket optional.  
Diffusion: Frosted. Clear optional.  
Hardware: Stainless steel hardware optional.  
Length: 50"  
Width: 6.75"  
Height: 5.63"  
Weight: 11.0 lbs.  
Shipping Weight: 13.0 lbs.

## Electrical System Characteristics / Data

AC Input: 120/277 VAC (standard), 480 VAC (upgrade)  
FCC: Title 47, Part 2, Part 15, Class A  
EM: Compliance to EN55015, EN55022 (CISPR22) Class B, EN61000-3-2 Class C (60% load); EN61000-3-3  
EM Immunity: Compliance to EN61000-4-2,3,4,5,6,8,11, EN61547, EN55024, light industry level (surge 4KV), criteria A  
Withstand Voltage: 1/P-O/P:3.75KVAC 1/P-FG:2KVAC O/P-FG:1.5KVAC  
Isolation Resistance: 1/P-O/P, 1/P-FG, O/P-FG:100M Ohms / 500VDC / 25 / 70% RH  
Power Factor: PF > 0.98/115VAC, PF > 0.92/277VAC  
Total Harmonic Distortion: THD < 20%  
Standard Surge Protection: All-Around Protection: OVP, SCP, OLP.  
Enhanced Surge Protection: Protects against surges according to IEEE C62.41.2 C and ANSI C136.2  
Emergency Battery Backup: Optional upgrades available.

## Optional Controls:

Wireless Controls: Optional via Pulse Wireless Mesh Network.  
Dimming: 0-10V, step, line voltage and bi-level available.  
Daylight Harvesting Sensor: Optional.  
Occupancy Sensor: Optional.

## Warranty

Five-Year Limited Warranty. Optional 10-Year Manufacturer's Warranty Available. Full Warranty Terms Available At [www.noribachi.com/products/warranty](http://www.noribachi.com/products/warranty)

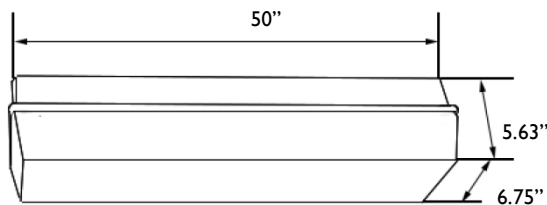

## Performance Specifications

Electrical Load				
Standard Order Code	Drive Current (Amps@120VAC)	Drive Current (Amps@277VAC)	Drive Current (Amps@480VAC)	System Power (Watts)*
LB4-LIN-024-B-CW-MT	0.33	0.14	0.08	39.70
LB4-LIN-036-B-CW-MT	0.50	0.21	0.12	59.50
LB4-LIN-048-B-CW-MT	0.66	0.29	0.17	79.40
LB4-LIN-054-B-CW-MT	0.74	0.32	0.19	89.30
LB4-LIN-072-B-CW-MT	0.99	0.43	0.25	119.10
LB4-LIN-084-B-CW-MT	1.16	0.50	0.29	138.90

\* ideal wattage

Operating Characteristics (Typical @5700K CCT)				
Standard Order Code	Lumens (Medium Dist)	Input Power (Watts)	Lumens per Watt	Replaces
LB4-LIN-024-B-CW-MT	5,557	39.70	139.97	90-185W
LB4-LIN-036-B-CW-MT	8,335	59.50	140.08	120-225W
LB4-LIN-048-B-CW-MT	11,113	79.40	139.96	100-225W
LB4-LIN-054-B-CW-MT	12,502	89.30	140.00	180-360W
LB4-LIN-072-B-CW-MT	16,670	119.10	139.97	225-435W
LB4-LIN-084-B-CW-MT	19,448	138.90	140.01	300-525W

## Fixture Specifications

### Construction

Durable polycarbonate housing with superior enamel finish.

### Optional Finishes

Custom colors available (specify RAL code). Epoxy finish and marine-grade coating available. Marine grade coating is green.

### Mounting Options

Surface mount is standard with commercial grade steel bracket mounting available.

### Lens Options

Frosted polycarbonate lens is standard. Clear lens option available.

### Light Distribution Patterns

T5 standard. 80degree option available.

## Electrical System Specifications

### Electrical System

Standard AC input of 120 – 277VAC. Optional upgrade to 480VAC. Driver meets maximum harmonic distortion (THD) of 20% and is ROHS compliant. Power Factor = > 0.9. Standard Surge protection according to IEC/EN 61000-4-5 EMC test standard and can protect against up to 4KV transient surge. Optional, enhanced Surge Protection protects Line-Ground, Line-Neutral, and Neutral-Ground. Protects against surges according to IEEE C62.41.2 C(10kA and 10kV) and ANSI C136.2.

### Controls

Optional controls include: 0-10V (010V), Step, line voltage and Bi-Level Dimming functionality (not guaranteed to work with all dimming systems). Occupancy and Daylight Harvest Sensors available. Optional Emergency Battery Backup: Nickel-Cadmium Batteries, 5W, 600 Lumens for 90 minutes. Optional Cold Emergency Battery Backup: 23W, 2000 Lumens for 90 minutes. The battery has a 7-10 year lifespan.

### Driver

All LED drivers provide constant current to give flicker free lighting. Two different drive currents are provided; A (350 mA) and B (525 mA). Highly reliable. Suitable for dry, damp and wet locations. Compliant to worldwide safety regulations for lighting

### Ambient Temperature

We provide fixtures that can sustain ambient temperature ranging from -40F to 140F (-40C to 60C).

### Wireless Control Options

Optional wireless networking using the Noribachi Pulse Wireless controller. Pulse is an Arduino-based hardware platform that provides communication between fixtures and a base station using Digi's XBEE based mesh network. Pulse controls up to 16 independent LED lighting fixtures using an FCC approved 900 MHz frequency with up to 200 Kbps data transmission speed. Transmit power output 50 mW. Data transmission rate is 156.25 kbps. 128 bit AES Encryption.

### Occupancy Sensor and Daylight Harvesting

Sensor provides 60' diameter coverage from a 40' height. Time can be set from 30 seconds to 30 minutes.

### RGBW Controls

Optional RGBW controls with communication to fixture via DMX512 or DMX256 and four channel controls. Four channel control uses red, green, blue and white (to control intensity). DMX controller optional, either software DMX master (via CD and USB adapter) or a physical DMX master. 2.4 GHz wireless DMX networking optional. Other frequencies available upon request.

### Testing Compliance

Noribachi complies with and exceeds standards set forth by UL and CSA. All luminaires comply with UL 1598 (CSA C22.2#250.13), and UL 8750 (CSA C22.2#250.0) standards for safety. Performance testing is done in accordance with LM-79 color measurements and LM-79 distribution measurements, and LM-80 lumen maintenance testing.

### Manufacturing

Manufactured in beautiful Harbor City, CA. ARRA Compliant. NAFTA Compliant. Test and burn-in of 100% of all luminaires before shipment. No less than 8-years experience in manufacturing LED-based products.

### Warranty

Standard limited 5-year warranty, first year includes labor. Optional 10-year warranty available. See details at [www.Noribachi.com](http://www.Noribachi.com).

### Note

All safety tests and performance data is done in ambient (STP) conditions. Specifications subject to change without notice. Actual performance may differ as a result of end-user environment application. Actual wattage may differ by +/- 8%. Lumen values may vary within compliance with ANSI C78-377 (unless specifying tight color bins).

## Distribution Types

Power and Lumens by Light Engine							
Distribution							
Light Engine	Drive	CCT	T1	T2	T3	T4	T5
LIN-024	B	5700	5,446	4,723	5,279	5,001	5,557
LIN-036	B	5700	8,168	6,501	7,918	7,502	8,335
LIN-048	B	5700	10,891	8,668	10,557	10,002	11,113
LIN-054	B	5700	12,252	10,627	11,877	11,252	12,502
LIN-072	B	5700	16,337	14,170	15,837	15,003	16,670
LIN-084	B	5700	19,059	16,531	18,476	17,503	19,448

Distribution types may not be applicable to all fixture configurations

### Type Distribution LIN-084

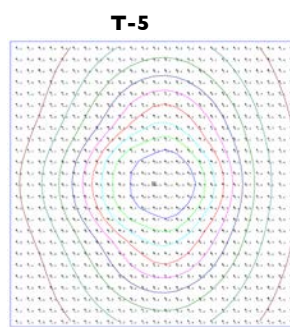
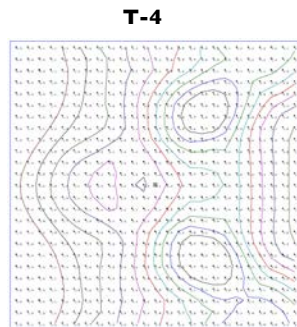
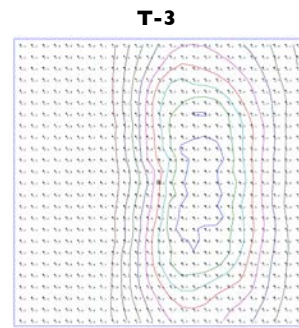
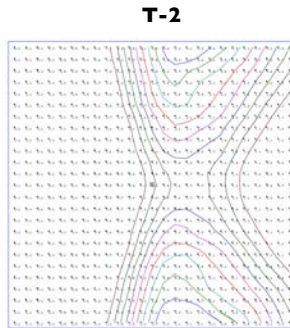
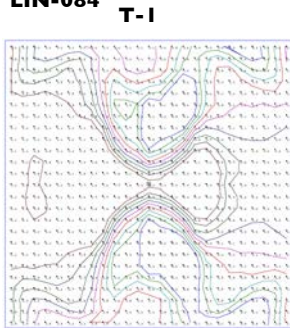

### Distribution

120° Standard Beam Spread. 80° Optional Beam Spread available for certain light engines. 40° Optional Beam Spread available for certain light engines. Other Light Engine Type Distribution available upon request.

Distribution types may not be applicable for all fixture configurations.

- IES Type Distributions are generated in an open space.
- Light Distribution images are mounted at 10 feet.

## Light Distribution Patters

Power and Lumens by Light Engine				
Light Engine	Wide	Medium	Narrow	Skinny
LIN-024-B	n/a	5,557	n/a	Optional
LIN-036-B	n/a	8,335	n/a	Optional
LIN-048-B	n/a	7,409	n/a	Optional
LIN-054-B	n/a	12,502	n/a	Optional
LIN-072-B	n/a	16,670	n/a	Optional
LIN-084-B	n/a	15,170	n/a	Optional

**Wide Pattern**

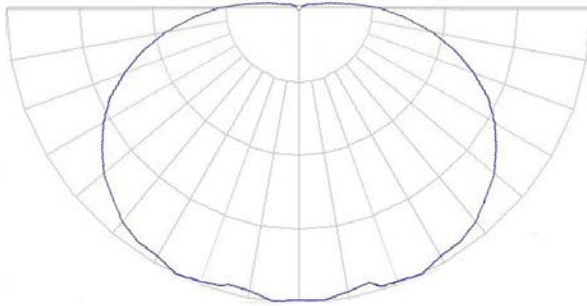

**Medium Pattern**  
(standard on all configurations)

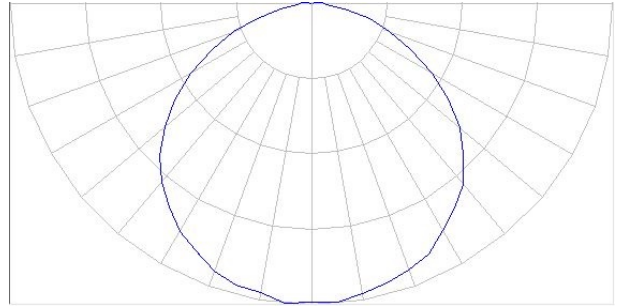

**Narrow Pattern**

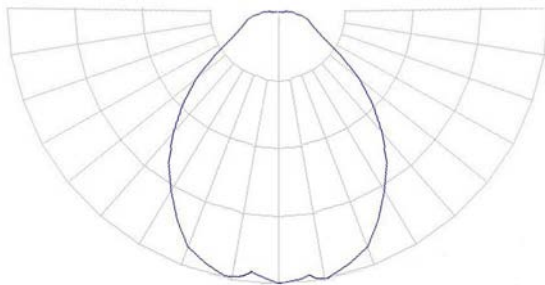

**Skinny Pattern**

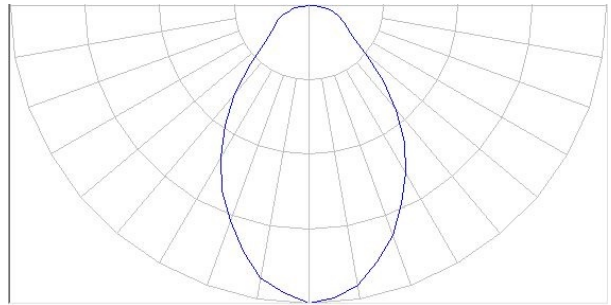

## Optics Specifications

### White LED Optics

High brightness, high efficiency LEDs. Standard color temperature is Cool White (5700K typical). Neutral White (4000K typical) and Warm White (3000K typical) also available. All with minimum 70 CRI. Tight bins (<math>\pm 50\text{degK}</math> variability) also available – recommended for WW installations as the eye is sensitive to variations in this color range. 40deg and 80deg beam angle optional (n/a for RGBW).

### RGBW Light Engine Optics

RGBW light engine also available, compatible with DMX controller. RGBW colors, to allow changing from pure white light to any hue available. Multiple channels of LEDs produce a full spectrum of light anywhere from deepest red to farthest violet. CRI greater than 75 in the 2700K – 4000K range.

Single color light engines also available. Red=630 nanometers, Green=525 nanometers. Blue=475 nanometers.

### Photometric Data for White LED Light Engine

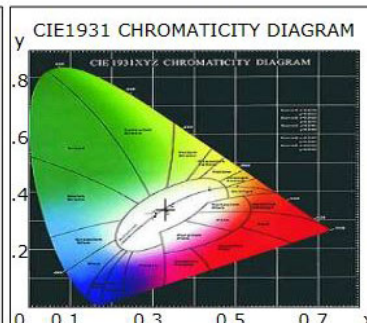
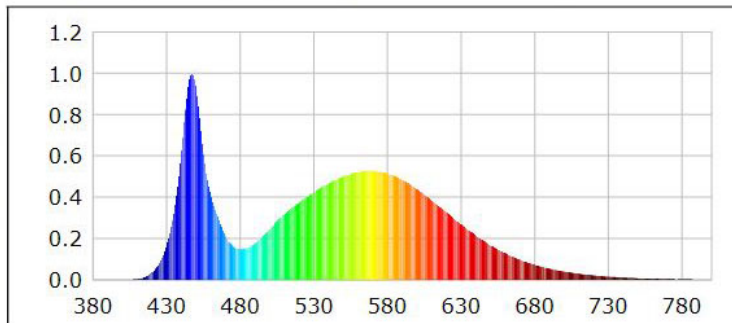

Chromaticity coordinates:  $x=0.3305$   $y=0.3424$   $u(u')=0.2050$   $v=0.3186$   $v'=0.4779$   
 CCT:  $T_c=5700\text{K}$  ( $duv=0.00156$ ) Color Ratio:  $R=0.133$   $G=0.827$   $B=0.040$   
 Peak Wavelength: 447.2nm Half Bandwidth: 19.1nm  
 Dominant Wavelength: 535.2nm Color Purity: 0.020  
 Color Render Index:  $R_a=75.0$ ,  $avgR(1\sim 14)=65.6$ ,  $avgR(1\sim 15)=65.9$   

R1 =74	R2 =76	R3 =76	R4 =81	R5 =75	R6 =66	R7 =84	R8 =67
R9 =0	R10=41	R11=78	R12=40	R13=73	R14=86	R15=71	

### Photometric Data for RGBW LED Light Engine

#### Chromaticity coordinates:

White  $x = 0.3405$ ,  $y = 0.3459$   
 Green  $x = 0.1687$ ,  $y = 0.7296$   
 Red  $x = 0.6968$ ,  $y = 0.3024$   
 Blue  $x = 0.1316$ ,  $y = 0.0636$

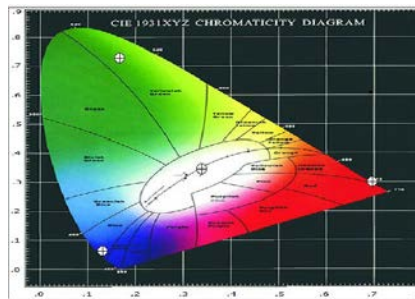

## Lumen Performance

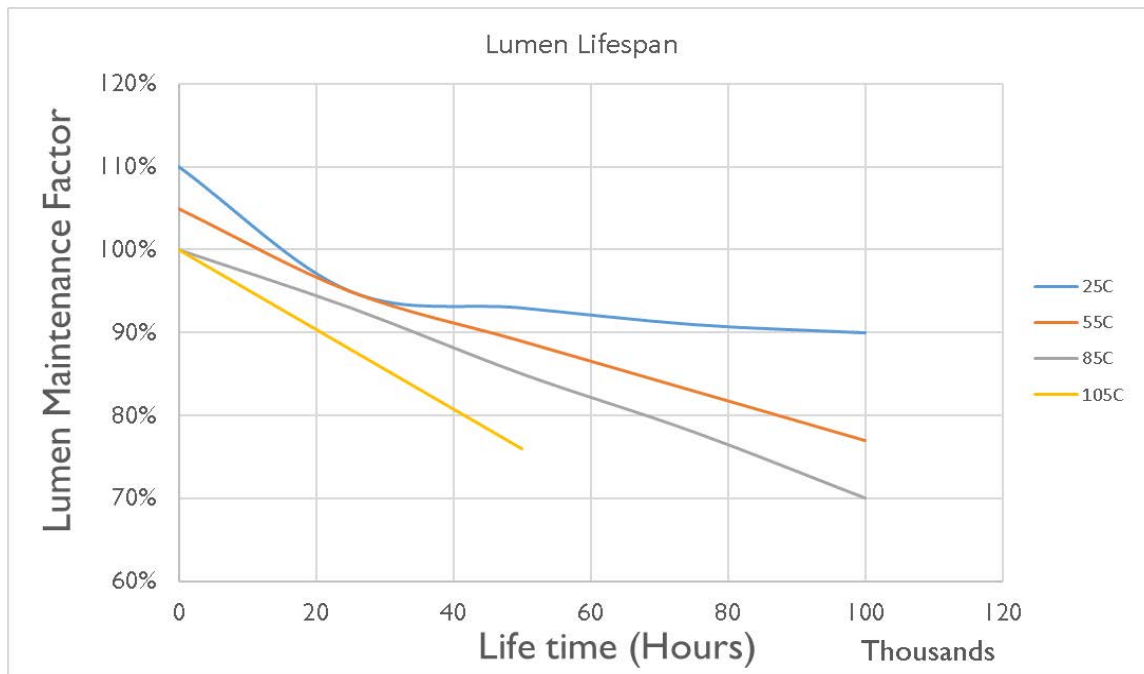

Lumen Maintenance Factors (B Drive)					
T <sub>j</sub> (Junction Temp)	INITIAL LMF	25K HR PROJECTED LMF	50K HR PROJECTED LMF	75K HR PROJECTED LMF	100K HR PROJECTED LMF
25°C	1.10	0.95	0.93	0.91	0.90
55°C	1.05	0.95	0.89	0.83	0.77
85°C	1.00	0.93	0.85	0.78	0.70
105°C	1.00	0.88	0.76	N/A	N/A

Each temperature has an independent initial value. In accordance with IESNA TM021011, Projected Values represent interpolated value based on time durations that are within six times (6X) the IESNA LM-80-08 total test duration (in hours) for the device under testing (DUT) i.e. the packaged LED chip. In accordance with IESNA TM-21-11, Calculated Values represent time durations that exceed six times (6X) the IESNA LM-80-08 total test duration (in hours) for the device under testing (DUT) i.e. the packaged LED chip.

Lumen Multiplier	
AMBIENT TEMPERATURE	LUMEN MULTIPLIER
10°C	1.032
15°C	1.021
25°C	1.000
40°C	0.968
50°C	0.946

## How to Order

Sample Order Code: Only include the optional upgrades you need.

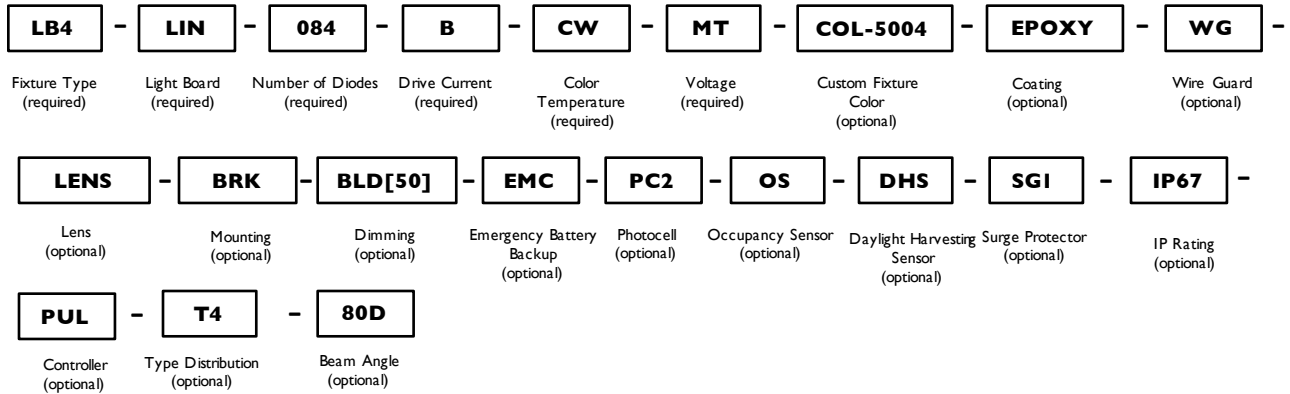

## Ordering Information

Numbering Order	Specification	Required or Optional	Allowed Values	Description
1	Fixture	Required	LB4	For Lowbay.4
2	Light Board	Required	LIN	For Lowbay.4
3	Light Engine	Required	024	For LIN-024 models
			036	For LIN-036 models
			048	For LIN-048models
			054	For LIN-054 models
			072	For LIN-072 models
			084	For LIN-084
4	Drive Current	Required	A	A (350 mA) drive current
			B	B (525 mA) drive current
5	LED Temperature	Required	CW	Standard Cool white (5700K)
			NW	Neutral white (4000K)
			WW	Warm white (3000K)
			[Specific degree Kelvin]	Specific color temp LEDs [Specific degree Kelvin]
			TB1 [Specific degree Kelvin]	Tight Bin LED Color [Specific degree Kelvin] for all models
			TB2 [Specific degree Kelvin]	Tight Bin LED Color [Specific degree Kelvin] for all models
			RGBW	Red/Green/Blue/White light engine
6	Voltage	Required	SCOL [R, G, B]	Single color light engine - Red, Green, Blue
			MT	Standard AC input: 120VAC - 277VAC
			HV1	High Voltage (480VAC) option for all models
7	Custom Fixture Color	Optional	HV2	High Voltage (480VAC) option for all models
			COL-[RAL]	Custom Fixture Color (RAL code)
8	Coating	Optional	EPOXY	Epoxy coating
			COAT	Marine Grade Coating (green)
9	Lens	Optional	CL	Clear lens



## How to Order (Cont.)

Sample Order Code: Only include the optional upgrades you need.

Numbering Order	Specification	Required or Optional	Allowed Values	Description
10	Mounting	Optional	BRK	Bracket
11	Dimming	Optional	010V	0 - 10V dimming
			STEP	Step dimming
			LVDIM	Line voltage dimming
			BLD [%]	Bi-level dimming
12	Emergency Battery Backup	Optional	EM	Emergency Battery Backup
			EMC	Emergency Battery Backup - Cold
13	Photocell	Optional	PC1	Photocell for 120V applications
			PC2	Photocell for 277V applications
14	Occupancy Sensor	Optional	OS	Occupancy Sensor
			OOS	Outdoor Occupancy Sensor
15	Daylight Harvesting Sensor	Optional	DHS	Daylight Harvesting Sensor
16	Surge Protection	Optional	SRG1	Enhanced surge protection for 120-277VAC
			SRG2	Enhanced surge protection for 480VAC
17	IP 67 Rating	Optional	IP67	IP 67 Rating Upgrade
18	Controller	Optional	PUL	Pulse Wireless Controller
19	Beam Angle	Optional	80D	80degree Beam Angle