

Product Information

The Vaporproof.CM is a heavy-duty LED lighting solution for extreme environments.

This LED lighting fixture features heavy-duty sand-cast aluminum housing with a clear glass lens.

Applications: Hazardous Environments, Warehouses, Walkways and a variety of other indoor and outdoor lighting applications.

Performance Ratings and Certifications

UL 1598
 UL 8750
 CSA C22.2#250.0
 CSA C22.2#250.13
 IP Rating: IP65
 NSF Certified

Performance Summary

Lumens: 3,704 - 5,557 lm
 Lumens Per Watt (Typical): 140 LPW
 Power Consumption: 27- 40 W
 Light Engine: L70 Rated Lifetime of 100,000+ hours
 CRI: Minimum 70 CRI. Optional custom CRI.
 CCT (Typical): 3000K, 4000K, 5700K, optional tight bins.
 Light Dist. Pattern: Multiple distribution patterns available.
 Manufactured and assembled in the U.S.

Fixture Information

Housing: Sand-casted aluminum
 Color: Gray with clear coat. Custom color also available.
 Finish: Superior dual coat finish. Chemical resistant epoxy primer and/or Marine Grade coating optional.
 Lens: Clear glass. Frosted optional.
 Mounting: Ceiling mount.
 Length: 11.5"
 Width: 5.13"
 Weight: 4.9 lbs.
 Shipping Weight: 5.8 lbs.

Electrical System Characteristics/ Data

AC Input: 120/277 VAC (standard), 480 VAC (upgrade)
 FCC: Title 47, Part 2, Part 15, Class A
 EM: Compliance to EN55015, EN55022 (CISPR22) Class B, EN61000-3-2 Class C (60% load); EN61000-3-3
 EM Immunity: Compliance to EN61000-4-2,3,4,5,6,8,11, EN61547, EN55024, light industry level (surge 4KV), criteria A
 Withstand Voltage: I/P-O/P:3.75KVAC I/P-FG:2KVAC O/P-FG:1.5KVAC
 Isolation Resistance: I/P-O/P, I/P-FG, O/P-FG:100M Ohms / 500VDC / 25 / 70% RH
 Power Factor: PF > 0.98/115VAC, PF > 0.92/277VAC
 Total Harmonic Distortion: THD < 20%
 Standard Surge Protection: All-Around Protection: OVP, SCP, OLP.
 Enhanced Surge Protection: Protects against surges according to IEEE C62.41.2 C and ANSI C136.2
 Emergency Batt. Backup: Optional upgrades available. (located remotely)

Optional Controls:

Wireless Controls: Optional via Pulse Wireless Mesh Network
 Dimming: 0-10V, step, bi-level and line voltage available. (located remotely)

Warranty

Standard limited 5-year warranty, first year includes labor. Optional 10-year warranty available. See details at www.Noribachi.com.

Electrical System Specifications

Electrical Load				
Light Engine	Drive Current (Amps@120VAC)	Drive Current (Amps@277VAC)	Drive Current (Amps@480VAC)	System Power (Watts)*
LIN-024-FIN-A-CW-MT	0.22	0.10	0.06	26.50
LIN-024-FIN-B-CW-MT	0.33	0.14	0.08	39.70
				* ideal wattage

Operating Characteristics (Typical @5700K CCT)				
Light Engine	Lumens (Medium Dist)	Input Power (Watts)	Lumens per Watt	Replaces
LIN-024-FIN-A-CW-MT	3,704	26.50	139.77	90-185W
LIN-024-FIN-B-CW-MT	5,557	39.70	139.97	90-185W

Fixture Specifications

Construction

For resistance and durability, the Vaporproof LED fixtures feature heavy-duty, die-cast aluminum housing with chromate conversion coating and textured grey powdercoat.

Optional Finishes

Custom colors available (specify RAL code). Optional Epoxy finish is available. Marine Grade Coating is also available (marine grade coating is green).

Lens Options

Durable clear and frosted polycarbonate lenses are available. Frosted lens is optional. Clear is standard.

Mounting Option

Ceiling mount available.

Light Distribution Patterns

T5 Standard. Optional 80deg available.

Electrical System Specifications

Electrical System

Standard AC input of 120 – 277VAC. Optional upgrade to 480VAC. Driver meets maximum harmonic distortion (THD) of 20% and is ROHS compliant. Power Factor = > 0.9. Standard Surge protection according to IEC/EN 61000-4-5 EMC test standard and can protect against up to 4KV transient surge. Optional, enhanced Surge Protection protects Line-Ground, Line-Neutral, and Neutral-Ground. Protects against surges according to IEEE C62.41.2 C(10kA and 10kV) and ANSI C136.2.

Controls

Optional controls include: 0-10V, Step, line voltage and Bi-Level Dimming functionality (not guaranteed to work with all dimming systems). Occupancy and Daylight Harvest Sensors available. Optional Emergency Battery Backup: Nickel-Cadmium Batteries, 5W, 600 Lumens for 90 minutes. Optional Cold Emergency Battery Backup: 23W, 2000 Lumens for 90 minutes. The battery has a 7-10 year lifespan.

Driver

All LED drivers provide constant current to give flicker free lighting. Two different drive currents are provided; A (350 mA) and B (525 mA). Highly reliable. Suitable for dry, damp and wet locations. Compliant to worldwide safety regulations for lighting.

Ambient Temperature

We provide fixtures that can sustain ambient temperature ranging from -40F to 140F (-40C to 60C).

Wireless Control Options

Optional wireless networking using the Noribachi Pulse Wireless controller. Pulse is an Arduino-based hardware platform that provides communication between fixtures and a base station using Digi's XBEE based mesh network. Pulse controls up to 16 independent LED lighting fixtures using an FCC approved 900 MHz frequency with up to 200 Kbps data transmission speed. Transmit power output 50 mW. Data transmission rate is 156.25 kbps. 128 bit AES Encryption.

Occupancy Sensor and Daylight Harvesting

Sensor provides 60' diameter coverage from a 40' height. Time can be set from 30 seconds to 30 minutes.

RGBW Controls

Optional RGBW controls with communication to fixture via DMX512 or DMX256 and four channel controls. Four channel control uses red, green, blue and white (to control intensity). DMX controller optional, either software DMX master (via CD and USB adapter) or a physical DMX master. 2.4 GHz wireless DMX networking optional. Other frequencies available upon request.

Testing Compliance

Noribachi complies with and exceeds standards set forth by UL and CSA. All luminaires comply with UL 1598 (CSA C22.2#250.13), and UL 8750 (CSA C22.2#250.0) standards for safety. Performance testing is done in accordance with LM-79 color measurements and LM-79 distribution measurements, and LM-80 lumen maintenance testing.

Manufacturing

Manufactured in beautiful Harbor City, CA. ARRA Compliant. NAFTA Compliant. Test and burn-in of 100% of all luminaires before shipment. No less than 8-years experience in manufacturing LED-based products.

Warranty

Standard limited 5-year warranty, first year includes labor. Optional 10-year warranty available. See details at www.Noribachi.com.

Note

All safety tests and performance data is done in ambient (STP) conditions. Specifications subject to change without notice. Actual performance may differ as a result of end-user environment application. Actual wattage may differ by +/- 8%. Lumen values may vary within compliance with ANSI C78-377 (unless specifying tight color bins).

Distribution Types

Power and Lumens by Light Engine							
Distribution							
Light Engine	Drive	CCT	T1	T2	T3	T4	T5
LIN-024-FIN	A	5700	3,630	3,148	3,519	3,334	3,704
LIN-024-FIN	B	5700	5,446	4,723	5,279	5,001	5,557

Distribution types may not be applicable to all fixture configurations.

Type Distribution LIN-024-FIN

T-1

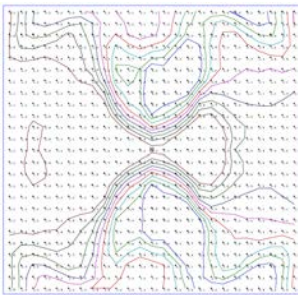

T-2

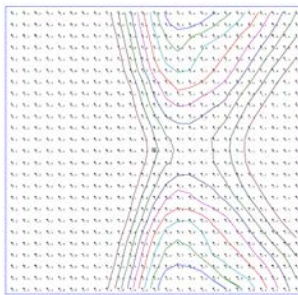

T-3

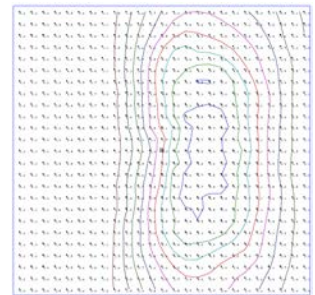

T-4

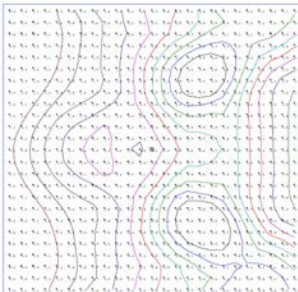

T-5

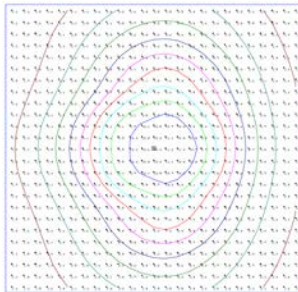

Distribution

120° Standard Beam Spread. 80° Optional Beam Spread available for certain light engines. 40° Optional Beam Spread available for certain light engines. Other Light Engine Type Distribution available upon request.

Distribution types may not be applicable for all fixture configurations.

- IES Type Distributions are generated in an open space.
- Light Distribution images are mounted at 10 feet.

Optics Specifications

White LED Optics

High brightness, high efficiency LEDs. Standard color temperature is Cool White (5700K typical), Neutral White (4000K typical) and Warm White (3000K typical) also available. All with minimum 70 CRI. Tight bins (<+/-50degK variability) also available – recommended for WW installations as the eye is sensitive to variations in this color range. 40deg and 80deg beam angle optional (n/a for RGBW).

RGBW Light Engine Optics

RGBW light engine also available, compatible with DMX controller. RGBW colors, to allow changing from pure white light to any hue available. Multiple channels of LEDs produce a full spectrum of light anywhere from deepest red to farthest violet. CRI greater than 75 in the 2700K – 4000K range.

Single color light engines also available. Red=630 nanometers, Green=525 nanometers. Blue=475 nanometers.

Photometric Data for White LED Light Engine

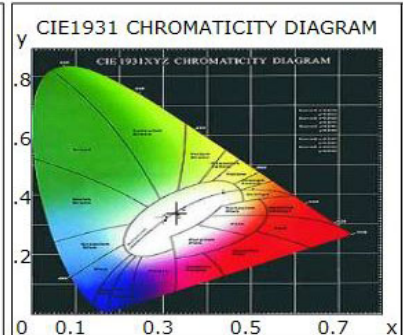
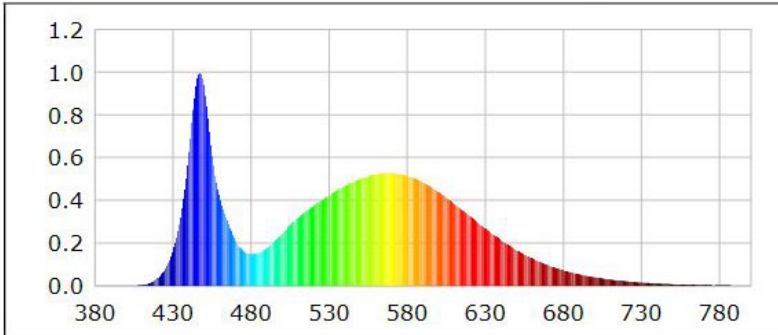

Chromaticity coordinates: $x=0.3305$ $y=0.3424$ $u(u')=0.2050$ $v=0.3186$ $v'=0.4779$
 CCT: $T_c=5700K$ ($duv=0.00156$) Color Ratio: $R=0.133$ $G=0.827$ $B=0.040$
 Peak Wavelength: 447.2nm Half Bandwidth: 19.1nm
 Dominant Wavelength: 535.2nm Color Purity: 0.020
 Color Render Index: $R_a=75.0$, $avgR(1\sim14)=65.6$, $avgR(1\sim15)=65.9$

R1 =74	R2 =76	R3 =76	R4 =81	R5 =75	R6 =66	R7 =84	R8 =67
R9 =0	R10=41	R11=78	R12=40	R13=73	R14=86	R15=71	

Photometric Data for RGBW LED Light Engine

Chromaticity coordinates:
 White $x = 0.3264$ $y = 0.3427$
 Red $x = 0.6977$ $y = 0.3014$
 Green $x = 0.1897$ $y = 0.7174$
 Blue $x = 0.1104$ $y = 0.1298$

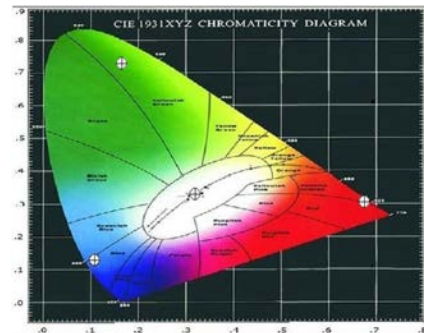

Lumen Performance

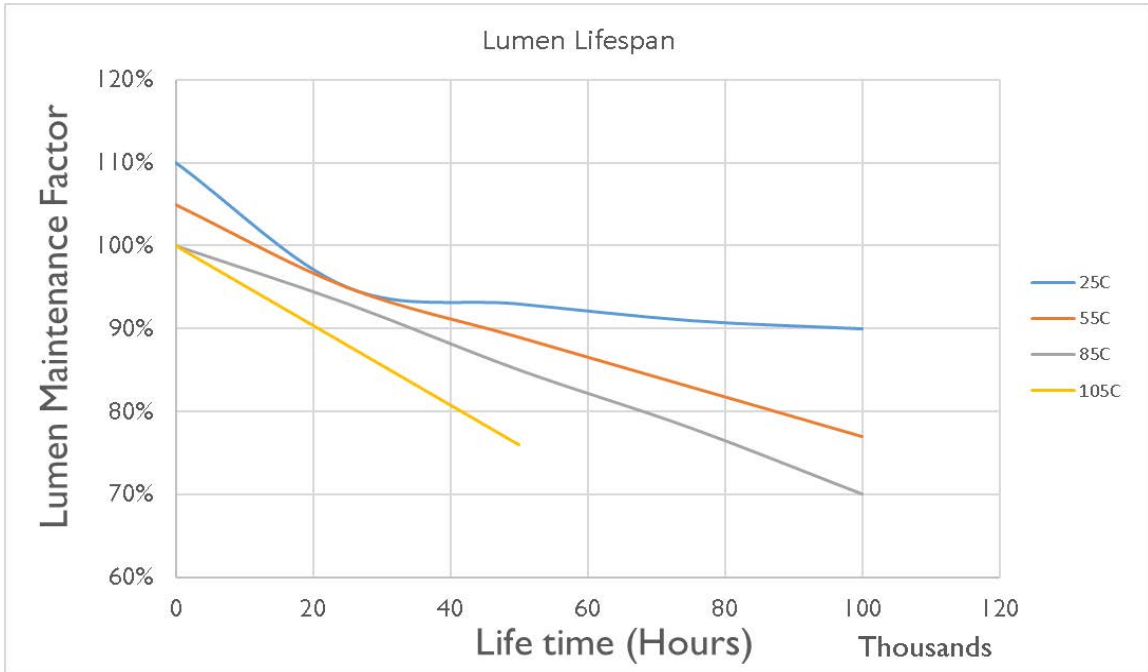

Lumen Maintenance Factors (B Drive)					
T _j (Junction Temp)	INITIAL LMF	25K HR PROJECTED LMF	50K HR PROJECTED LMF	75K HR PROJECTED LMF	100K HR PROJECTED LMF
25°C	1.10	0.95	0.93	0.91	0.90
55°C	1.05	0.95	0.89	0.83	0.77
85°C	1.00	0.93	0.85	0.78	0.70
105°C	1.00	0.88	0.76	N/A	N/A

Each temperature has an independent initial value. In accordance with IESNA TM021011, Projected Values represent interpolated value based on time durations that are within six times (6X) the IESNA LM-80-08 total test duration (in hours) for the device under testing (DUT) i.e. the packaged LED chip). In accordance with IESNA TM-21-11, Calculated Values represent time durations that exceed six times (6X) the IESNA LM-80-08 total test duration (in hours) for the device under testing (DUT) i.e. the packaged LED chip).

Lumen Multiplier	
AMBIENT TEMPERATURE	LUMEN MULTIPLIER
10°C	1.032
15°C	1.021
25°C	1.000
40°C	0.968
50°C	0.946

How to Order

Sample Order Code: Only include the optional upgrades you need.

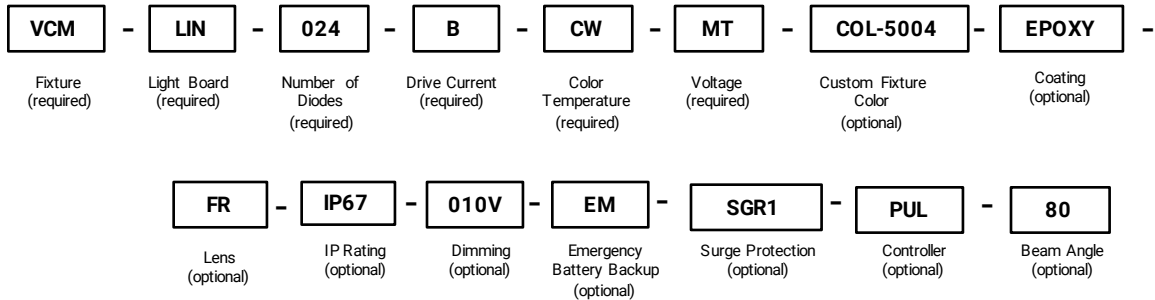

Numbering Order	Specification	Required or Optional	Allowed Values	Description
1	Fixture	Required	VCM	For VCM
2	Light Board	Required	LIN	For VCM
3	Number of Diodes	Required	024	For VCM
4	Drive Current	Required	A	A (350mA)
			B	B (525mA)
5	LED Color Temperature	Required	CW	Standard Cool White LEDs (5700K)
			NW	Neutral White LEDs (4000K)
			WW	Warm White LEDs (3000K)
			[Specific degree Kelvin]	Specific color temp LEDs [Specific degree Kelvin]
			TB1 [Specific degree Kelvin]	Tight Bin LED Color [Specific degree Kelvin] for all models
			TB2 [Specific degree Kelvin]	Tight Bin LED Color [Specific degree Kelvin] for all models
			RGBW	Red/Green/Blue/White light engine
6	Voltage	Required	MT	Standard AC input: 120VAC - 277VAC
			HV1	High Voltage (480VAC) (located remotely)
7	Custom Fixture Color	Optional	COL-[RAL]	Custom Fixture Color (RAL code)
8	Coating	Optional	EPOXY	Epoxy coating
9	Lens	Optional	FR	Frosted polycarbonate lens
			CL	Clear polycarbonate lens
			TFR	Frosted tempered glass lens
10	IP Rating	Optional	IP67	IP67 Rating
11	Dimming	Optional	010V	0 - 10V dimming
			STEP	Step dimming
			LVDIM	Line voltage
			BLD [%]	Bi-level dimming
12	Emergency Battery Backup	Optional	EM	Emergency Battery Backup (located remotely)
			EMC	Emergency Battery Backup - Cold (located remotely)
13	Surge Protection	Optional	SRG1	Enhanced surge protection for 120-277VAC
			SRG2	Enhanced surge protection for 480VAC
14	Controller	Optional	PUL	Pulse Wireless Controller
15	Beam Angle	Optional	80D	80 degree beam angle optics