

### Product Information

The Floodlight.K is a heavy-duty, compact, energy-efficient LED lighting solution.

This LED fixture features die cast aluminum housing and post top or ground stake mounting options.

The Floodlight.K is the perfect LED lighting solution for parking lots, recreational areas, signage, wall washing and a variety of other general outdoor areas.



Shown with non-standard frosted lens

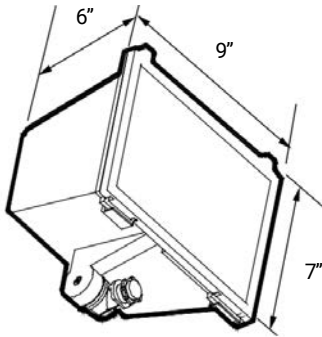

### Performance Ratings and Certifications

UL 1598  
UL 8750  
CSA C22.2#250.0  
CSA C22.2#250.1  
IP Rating: IP65

### Performance Summary

Lumens:	9,724 lm
Lumens Per Watt (typ.):	140.01
Power Consumption:	69.5 W
Light Engine:	L70 Rated Lifetime of 100,000+ hours.
CRI:	Minimum 70 CRI. Optional custom CRI.
CCT (Typical):	3000K, 4000K, 5700K, optional tight bins.
Light Dist. Pattern:	Multiple distribution patterns available.
Manufactured in the U.S. with parts from U.S. and imported.	

### Fixture Information

Housing:	Die cast aluminum
Color:	Bronze with clear coat. Optional custom color
Finish:	Textured powdercoat finish over a chromate conversion coating. Custom colors available upon request.
Lens:	Tempered clear flat glass. Optional polycarbonate vandal proof lens, prismatic glass lens
Mounting:	Knuckle mount standard. Post top and Ground stake optional.
Other Optional Options:	Visor, Wire Guard
Height:	7"
Width:	9"
Length:	6"
Weight:	9 lbs.
Shipping Weight:	13 lbs.

### Electrical System Characteristics / Data

AC Input:	120/277 VAC (standard)
FCC:	Title 47, Part 2, Part 15, Class A
EM:	Compliance to EN55015, EN55022 (CISPR22) Class B, EN61000-3-2 Class C (60% load); EN61000-3-3
EM Immunity:	Compliance to EN61000-4-2,3,4,5,6,8,11, EN61547, EN55024, light industry level (surge 4KV), criteria A
Withstand Voltage:	I/P-O/P: 3.75KVAC I/P-FG: 2KVAC O/P-FG: 1.5KVAC
Isolation Resistance:	I/P-O/P, I/P-FG, O/P-FG: 100M Ohms / 500VDC / 25 / 70% RH
Power Factor:	PF > 0.98/115VAC, PF > 0.92/277VAC
Total Harmonic Distortion:	THD < 20%
Standard Surge Protection:	All-Around Protection: OVP, SCP, OLP.
Enhanced Surge Protection:	Protects against surges according to IEEE C62.41.2 C and ANSI C136.2
Emergency Battery Backup:	Optional upgrades available.

### Optional Controls:

Wireless Controls:	Optional via Pulse Wireless Mesh Network.
Dimming:	0-10V, step, line voltage and bi-level available.
Daylight Harvesting Sensor:	Optional.
Occupancy Sensor:	Optional.

### Warranty

Five-Year Limited Warranty. Optional 10-Year Manufacturer's Warranty Available. Full Warranty Terms Available At [www.noribachi.com/products/warranty](http://www.noribachi.com/products/warranty)

## Electrical System Specifications

Electrical Load				
Standard Order Code	Drive Current (Amps@120VAC)	Drive Current (Amps@277VAC)	Drive Current (Amps@480VAC)	System Power (Watts)*
HEX-042-B-CW-MT	0.58	0.25	0.14	69.5
				* ideal wattage

Operating Characteristics (Typical @5700K CCT)				
Standard Order Code	Lumens (Medium Dist)	Input Power (Watts)	Lumens per Watt	Replaces
HEX-042-B-CW-MT	9,724	69.5	140 LPW	125-300W

## Fixture Specifications

### Construction

Die cast aluminum housing.

### Optional Finishes

Custom colors available (specify RAL code). Epoxy finish and marine-grade coating available. Marine grade coating is green.

### Mounting Options

Knuckle mount standard. Post top and ground stake mounts optional.

### Lens Options

Tempered clear flat glass standard. Optional polycarbonate vandal proof lens, prismatic glass lens available.

### Light Distribution Patterns

T5 standard. 80degree option available.

## Electrical System Specifications

### Electrical System

Standard AC input of 120 – 277VAC. Optional upgrade to 480VAC. Driver meets maximum harmonic distortion (THD) of 20% and is ROHS compliant. Power Factor = > 0.9. Standard Surge protection according to IEC/EN 61000-4-5 EMC test standard and can protect against up to 4KV transient surge. Optional, enhanced Surge Protection protects Line-Ground, Line-Neutral, and Neutral-Ground. Protects against surges according to IEEE C62.41.2 C(10kA and 10kV) and ANSI C136.2.

### Controls

Optional controls include: 0-10V, Step, line voltage and Bi-Level Dimming functionality (not guaranteed to work with all dimming systems). Occupancy and Daylight Harvest Sensors available. Optional Emergency Battery Backup: Nickel-Cadmium Batteries, 5W, 600 Lumens for 90 minutes. Optional Cold Emergency Battery Backup: 23W, 2000 Lumens for 90 minutes. The battery has a 7-10 year lifespan.

### Driver

All LED drivers provide constant current to give flicker free lighting. Two different drive currents are provided; A (350 mA) and B (525 mA). Highly reliable. Suitable for dry, damp and wet locations. Compliant to worldwide safety regulations for lighting.

### Ambient Temperature

We provide fixtures that can sustain ambient temperature ranging from -40F to 140F (-40C to 60C).

### Wireless Control Options

Optional wireless networking using the Noribachi Pulse Wireless controller. Pulse is an Arduino-based hardware platform that provides communication between fixtures and a base station using Digi's XBEE based mesh network. Pulse controls up to 16 independent LED lighting fixtures using an FCC approved 900 MHz frequency with up to 200 Kbps data transmission speed. Transmit power output 50 mW. Data transmission rate is 156.25 kbps. 128 bit AES Encryption.

### Occupancy Sensor and Daylight Harvesting

Sensor provides 60' diameter coverage from a 40' height. Time can be set from 30 seconds to 30 minutes.

### RGBW Controls

Optional RGBW controls with communication to fixture via DMX512 or DMX256 and four channel controls. Four channel control uses red, green, blue and white (to control intensity). DMX controller optional, either software DMX master (via CD and USB adapter) or a physical DMX master. 2.4 GHz wireless DMX networking optional. Other frequencies available upon request.

### Testing Compliance

Noribachi complies with and exceeds standards set forth by UL and CSA. All luminaires comply with UL 1598 (CSA C22.2#250.13), and UL 8750 (CSA C22.2#250.0) standards for safety. Performance testing is done in accordance with LM-79 color measurements and LM-79 distribution measurements, and LM-80 lumen maintenance testing.

### Manufacturing

Manufactured in beautiful Harbor City, CA. ARRA Compliant. NAFTA Compliant. Test and burn-in of 100% of all luminaires before shipment. No less than 8-years experience in manufacturing LED-based products.

### Warranty

Standard limited 5-year warranty, first year includes labor. Optional 10-year warranty available. See details at [www.Noribachi.com](http://www.Noribachi.com).

### Note

All safety tests and performance data is done in ambient (STP) conditions. Specifications subject to change without notice. Actual performance may differ as a result of end-user environment application. Actual wattage may differ by +/- 8%. Lumen values may vary within compliance with ANSI C78-377 (unless specifying tight color bins).

## Distribution Types

Power and Lumens by Light Engine							
Distribution							
Light Engine	Drive	CCT	T1	T2	T3	T4	T5
HEX-042	B	5700	4,992	3,973	4,839	4,584	9,724

Distribution types may not be applicable to all fixture configurations

### Type Distribution HEX-042

T-1

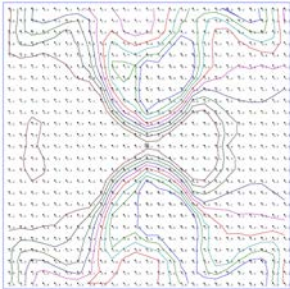

T-2

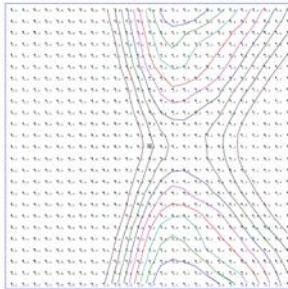

T-3

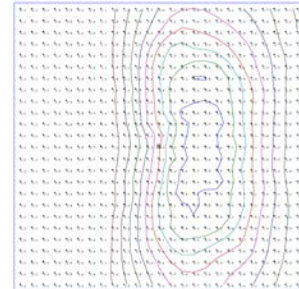

T-4

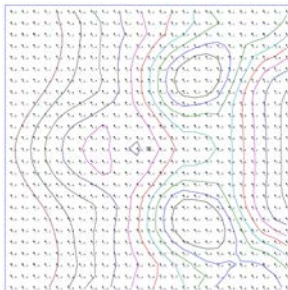

T-5

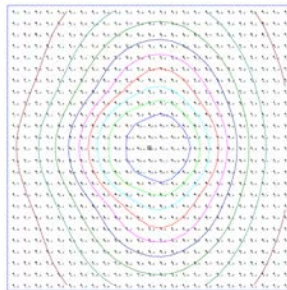

### Distribution

120° Standard Beam Spread. 80° Optional Beam Spread available for certain light engines. 40° Optional Beam Spread available for certain light engines. Other Light Engine Type Distribution available upon request.

Distribution types may not be applicable for all fixture configurations.

•IES Type Distributions are generated in an open space.  
•Light Distribution images are mounted at 10 feet.

## Optics Specifications

### White LED Optics

High brightness, high efficiency LEDs. Standard color temperature is Cool White (5700K typical). Neutral White (4000K typical) and Warm White (3000K typical) also available. All with minimum 70 CRI. Tight bins (<math>\pm 50\text{degK}</math> variability) also available - recommended for WW installations as the eye is sensitive to variations in this color range. 40deg and 80deg beam angle optional (n/a for RGBW).

### RGBW Light Engine Optics

RGBW light engine also available, compatible with DMX controller. RGBW colors, to allow changing from pure white light to any hue available. Multiple channels of LEDs produce a full spectrum of light anywhere from deepest red to farthest violet. CRI greater than 75 in the 2700K - 4000K range.

Single color light engines also available. Red=630 nanometers, Green=525 nanometers. Blue=475 nanometers.

### Photometric Data for White LED Light Engine

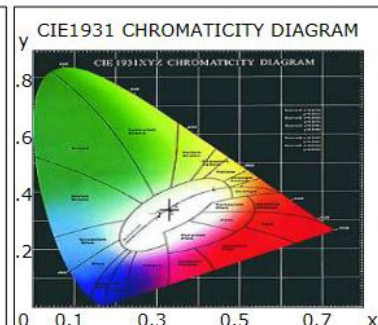
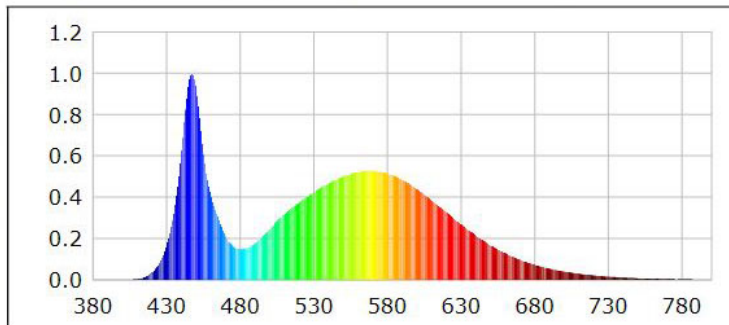

Chromaticity coordinates:  $x=0.3305$   $y=0.3424$   $u(u')=0.2050$   $v=0.3186$   $v'=0.4779$   
 CCT:  $T_c=5700\text{K}$  ( $duv=0.00156$ ) Color Ratio: R=0.133 G=0.827 B=0.040  
 Peak Wavelength: 447.2nm Half Bandwidth: 19.1nm  
 Dominant Wavelength: 535.2nm Color Purity: 0.020  
 Color Render Index: Ra= 75.0, avgR(1~14)= 65.6, avgR(1~15)= 65.9  
 R1 =74 R2 =76 R3 =76 R4 =81 R5 =75 R6 =66 R7 =84 R8 =67  
 R9 =0 R10=41 R11=78 R12=40 R13=73 R14=86 R15=71

### Photometric Data for RGBW LED Light Engine

#### Chromaticity coordinates:

White  $x = 0.3405$ ,  $y = 0.3459$   
 Green  $x = 0.1687$ ,  $y = 0.7296$   
 Red  $x = 0.6968$ ,  $y = 0.3024$   
 Blue  $x = 0.1316$ ,  $y = 0.0636$

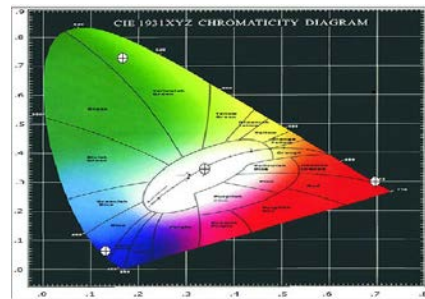

## Lumen Performance

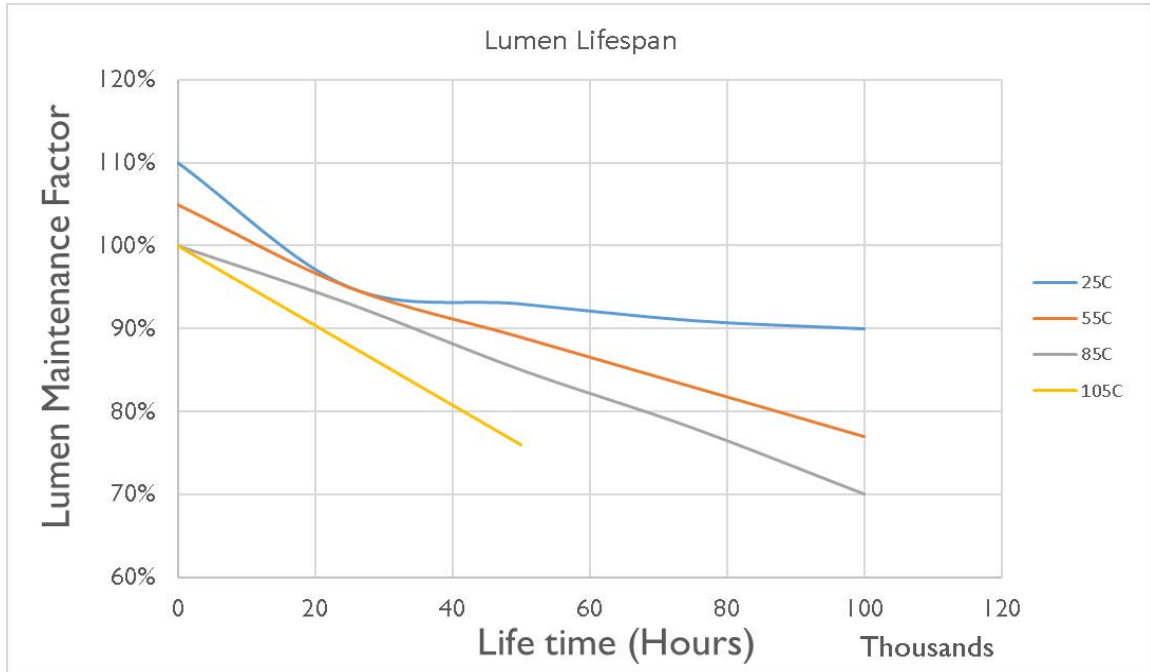

Lumen Maintenance Factors (B Drive)					
T <sub>j</sub> (Junction Temp)	INITIAL LMF	25K HR PROJECTED LMF	50K HR PROJECTED LMF	75K HR PROJECTED LMF	100K HR PROJECTED LMF
25°C	1.10	0.95	0.93	0.91	0.90
55°C	1.05	0.95	0.89	0.83	0.77
85°C	1.00	0.93	0.85	0.78	0.70
105°C	1.00	0.88	0.76	N/A	N/A

Each temperature has an independent initial value. In accordance with IESNA TM021011, Projected Values represent interpolated value based on time durations that are within six times (6X) the IESNA LM-80-08 total test duration (in hours) for the device under testing (DUT) i.e. the packaged LED chip). In accordance with IESNA TM-21-11, Calculated Values represent time durations that exceed six times (6X) the IESNA LM-80-08 total test duration (in hours) for the device under testing (DUT) i.e. the packaged LED chip).

Lumen Multiplier	
AMBIENT TEMPERATURE	LUMEN MULTIPLIER
10°C	1.032
15°C	1.021
25°C	1.000
40°C	0.968
50°C	0.946

# FLOODLIGHT.K

## How to Order

Sample Order Code: Only include the optional upgrades you need.

<b>FLK</b>	-	<b>HEX</b>	-	<b>042</b>	-	<b>B</b>	-	<b>CW</b>	-	<b>MT</b>	-	<b>GS</b>	-	<b>COL-5004</b>	-	<b>EPOXY</b>	-
Fixture (required)		Light Board (required)		Number of Diodes (required)		Drive Current (required)		LED Color Temperature (required)		Voltage (required)		Mounting (optional)		Custom Fixture Color (optional)		Coating (optional)	
<b>PRIS</b>	-	<b>WG</b>	-	<b>BLD[50]</b>	-	<b>EM120</b>	-	<b>PC2</b>	-	<b>SG1</b>	-	<b>OS</b>	-	<b>PUL</b>	-	<b>80D</b>	
Lens (optional)		Wire Guard (optional)		Dimming (optional)		Emergency Battery Backup (optional)		Photocell (optional)		Surge Protector (optional)		Occupancy Sensor (optional)		Controller (optional)		Beam Angle (optional)	

Numbering Order	Specification	Required or Optional	Allowed Values	Description
1	Fixture	Required	Floodlight.K	For FLK
2	Light Board	Required	HEX	For FLK
3	Number of Diodes	Required	042	For HEX-042
4	Drive Current	Required	B	B (525mA) drive current
5	LED Color Temperature	Required	CW	Standard Cool white LEDs (5700K)
			NW	Neutral White LEDs (4000K)
			WW	Warm White LEDs (3000K)
			[Specific degree Kelvin]	Specific color temp LEDs [Specific degree Kelvin]
			TB1 [Specific degree Kelvin]	Tight Bin LED Color [Specific degree Kelvin]
			TB2 [Specific degree Kelvin]	Tight Bin LED Color [Specific degree Kelvin]
6	Voltage	Required	MT	Standard AC input: 120VAC - 277VAC
			PTM	Post Top Mount (knuckle mount required)
7	Mounting	Optional	GS	Ground Stake Mount (knuckle mount required)
			COL-[RAL]	Custom Fixture Color (RAL code)
8	Custom Fixture Color	Optional	COAT	Marine Grade Coating
			EPOXY	Epoxy Coating
9	Coating	Optional	GL	Glass Lens
			PRIS	Prismatic Lens
			VRGL	Vandal Resistant Guard Lens
			WG	Wire Guard
10	Lens	Optional	010V	0 - 10V dimming
			STEP	Step dimming
			LVDIM	Line voltage dimming
			BLD [% }	Bi-level dimming
11	Wire Guard	Optional	EM120	Emergency Battery Backup 120V
			EM277	Emergency Battery Backup 277V
12	Emergency Battery Backup	Optional	PC1	120V Button Photocell
			PC2	208-277 Button Photocell
13	Photocell	Optional	SGR1	100-277V Surge Protector
			SGR2	208-277 Surge Protector
14	Surge Protection	Optional	OOS	Outdoor Occupancy Sensor
15	Occupancy Sensor	Optional	PUL	Pulse Wireless Controller
16	Controller	Optional	80D	80 degree beam angle
17	Beam Angle	Optional		

