

SHOEBOX.M



Performance Ratings and Certifications

UL 1598
UL 8750
CSA C22.2#250.0
CSA C22.2#250.13

Design

LED Channels: Red, Green, Blue & White
Standard White: Cool White (5000K)
Optics: 120° STD, 40° option

Performance

Mixing Distance: 1 ft
Lumens: 5,166 – 9,958 lumens
Efficacy: 80.4 - 85.5 LPW

Fixture Information

Housing: Precision die-cast aluminum
Color: Bronze. Custom color also available
Finish: Superior dual coat finish. Chemical resistant epoxy primer and/or Marine Grade coating optional
Lens: Clear. Frosted optional
Optional Wire Guard: Steel wire with chromized coating
Mounting: Slip-fitter, trunion, arm mount, heavy-duty adjustable pole mount arm, wall mount bracket
Dimensions (LxWxD): 16.63" x 16.13" x 7"
Weight / Shipping Weight: 22.2 lbs. / 25.7 lbs.

Controls

Driver info: 100 Watt DMX Driver
Controllers: Software Application, Wall mount Controller, Custom Controller
Connection types: Wireless, Hardwired

Electrical Characteristics

AC input: 120-277 VAC
Power Consumption: 60.4 – 123.9 Watts
EMI Filter: 47 CFR, part 15, Class B
Power Factor: >0.9
Total Harmonics Distortion: <10%
Surge Protection: 3kV (L to N), 4kV (L/N to GND)
Enhanced Surge Protection: According to IEEE C62.41.2 C and ANSI C136.2

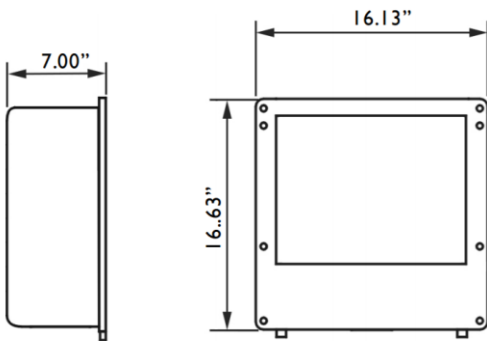

ELECTRICAL CHARACTERISTICS AND PERFORMANCE DATA VERIFIED BY NATIONALLY RECOGNIZED TESTING LABS (NRTL). FOR FULL REPORTS AND RESULTS, VISIT WWW.NORIBACHI.COM/REPORTS. ALL SPECIFICATIONS SUBJECT TO CHANGE WITHOUT NOTICE. ALL VALUES TYPICAL UNLESS OTHERWISE NOTED. LUMEN VALUES MAY VARY BY +/-10%. COLOR TEMPERATURE MAY VARY ACCORDING TO ANSI C78.377. ©2015 - 2016



Performance Specifications

Electrical Load

| Light Engine | Drive current (Amps@120VAC) | Drive Current (Amps@277VA) | Drive Current (Amps@480VA) | System Power (Watts) |
|--------------|-----------------------------|----------------------------|----------------------------|----------------------|
| SBM-HEX-126 | 1.03 | 0.45 | 0.26 | 123.9 W |

Operating Characteristics

| Light Engine | Light Engine Channel | Lumens | Input Power | Lumens per Watt (Efficacy) |
|--------------|----------------------|--------|-------------|----------------------------|
| SBM-HEX-126 | Red – 30 LEDs | 1730 | 20.3 W | 85.1 |
| | Green – 30 LEDs | 2952 | 34.1 W | 86.5 |
| | Blue – 30 LEDs | 1160 | 31.6 W | 36.7 |
| | White – 36 LEDs | 4117 | 37.9 W | 108.7 |
| | RGBW – 126 LEDs | 9958 | 123.9 W | 80.4 |

ELECTRICAL CHARACTERISTICS AND PERFORMANCE DATA VERIFIED BY NATIONALLY RECOGNIZED TESTING LABS (NRTL). FOR FULL REPORTS AND RESULTS, VISIT WWW.NORIBACHI.COM/REPORTS. ALL SPECIFICATIONS SUBJECT TO CHANGE WITHOUT NOTICE. ALL VALUES TYPICAL UNLESS OTHERWISE NOTED. LUMEN VALUES MAY VARY BY +/-10%. COLOR TEMPERATURE MAY VARY ACCORDING TO ANSI C78.377. ©2015 - 2016



System Specifications

Construction

This fixture features precision die-cast aluminum housing, a superior dual coat finish and clear lens.

Manufacturing

Manufactured in beautiful Harbor City, CA. ARRA Compliant. NAFTA Compliant. Test and burn-in of 100% of all luminaires before shipment. No less than 8-years experience in manufacturing LED-based products.

Certifications

Noribachi complies with and exceeds standards set forth by UL and CSA. All luminaires comply with UL1598 (CSA C22.2#250.13) standards for safety. Performance testing is done in accordance with LM-79 Electrical and Photometric Measurements of Solid State lighting and LM-80 Lumen Depreciation Analysis for Solid State Lighting.

Electrical System

Standard AC input of 120-277VAC. Optional upgrade to 480VAC. Driver has total harmonic distortion (THD) less than 20% on full load power factor – 0.9. Standard Surge protection with an optional enhanced surge protection that protects Line-Ground, Line-Neutral and Neutral-Ground. Protects against surges according to IEEE C62.41.2 C (10kA and 10kV) and ANSI C136.2.

Driver

UL recognized component (UL1310 (class 2 output) & 8750). Highly reliable. Suitable for dry locations. Compliant to worldwide safety regulations for lighting.

Controls

Communication to fixture via DMX512 or DMX256 with four channel controls, ability to control up to 512 different fixtures/groups separately. The controls system is able to control four different color channels with the ability to dim each color. There are two different types of controllers offered. Please see Controller Specifications for more information and how to order the controllers.

Wired DMX Connections

Wired connections are the standard form of DMX connections. With input and output DMX connections on each fixture, the fixtures are easy to connect and effectively communicate RGBW control commands.

Wireless DMX Connections

Optional wireless DMX connection available. Wireless control includes a transmitter connected to the controller and desired number of receivers located in each fixture. The system uses a 2.4 GHz wireless DMX signal to pass along the RGBW control commands. The solution allows easy RGBW installation without introducing new wiring to your lighting system.

Optics

Multiple channels of LEDs produce a full spectrum of light anywhere from deepest red to farthest violet. CRI greater than 75 in the 2700k – 4000K range. Single color and custom light color available upon request. 40 degree lens available for all Noribachi Hex applications.

Ambient Temperature

We provide fixtures that can sustain ambient temperature ranging from (-20C) – (50C) / (-4F) – (122F).

ELECTRICAL CHARACTERISTICS AND PERFORMANCE DATA VERIFIED BY NATIONALLY RECOGNIZED TESTING LABS (NRTL). FOR FULL REPORTS AND RESULTS, VISIT WWW.NORIBACHI.COM/REPORTS. ALL SPECIFICATIONS SUBJECT TO CHANGE WITHOUT NOTICE. ALL VALUES TYPICAL UNLESS OTHERWISE NOTED. LUMEN VALUES MAY VARY BY +/-10%. COLOR TEMPERATURE MAY VARY ACCORDING TO ANSI C78.377. ©2015 - 2016



Distribution Data

| | SBM | HEX-126 |
|----------|------------|-------------|
| Distance | Beam Angle | Center Beam |
| 4 ft | 40° | 294 fc |
| 8 ft | 40° | 206 fc |
| 12 ft | 40° | 107 fc |
| 16 ft | 40° | 64.1 fc |
| 20 ft | 40° | 42.3 fc |
| 24 ft | 40° | 30.0 fc |

120 degree Beam Angle Standard

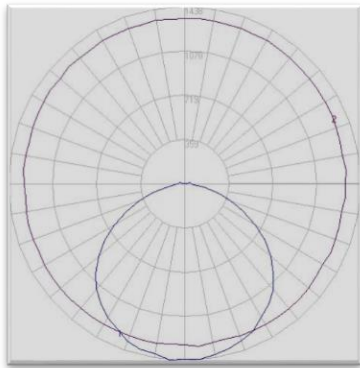

- Top View (Purple Larger Plot)
- Side View (Blue Smaller Plot)

40 degree Beam Angle Optional Configuration

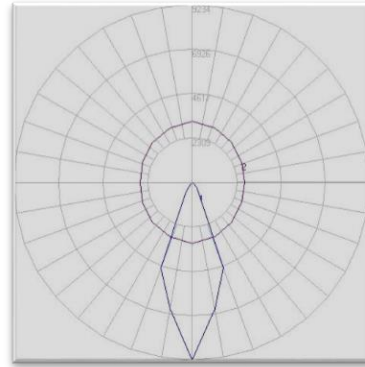

- Top View (Purple Larger Plot)
- Side View (Blue Smaller Plot)

ELECTRICAL CHARACTERISTICS AND PERFORMANCE DATA VERIFIED BY NATIONALLY RECOGNIZED TESTING LABS (NRTL). FOR FULL REPORTS AND RESULTS, VISIT WWW.NORIBACHI.COM/REPORTS. ALL SPECIFICATIONS SUBJECT TO CHANGE WITHOUT NOTICE. ALL VALUES TYPICAL UNLESS OTHERWISE NOTED. LUMEN VALUES MAY VARY BY +/-10%. COLOR TEMPERATURE MAY VARY ACCORDING TO ANSI C78.377. ©2015 - 2016



Photometric Data

Blue
Peak: 470 nm

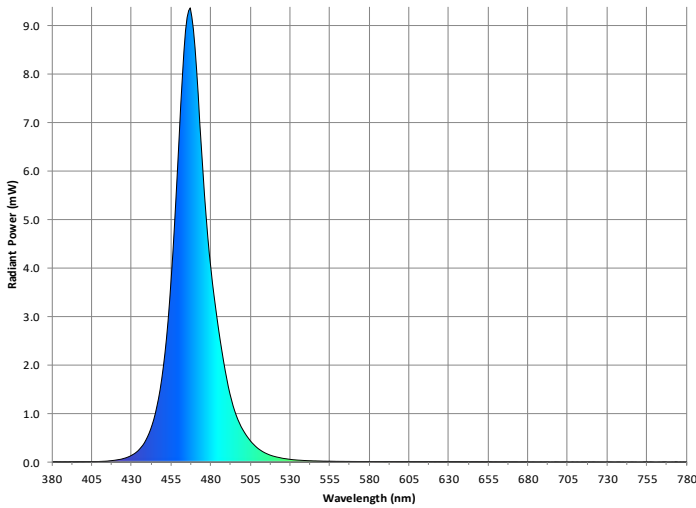

Green
Peak: 520 nm

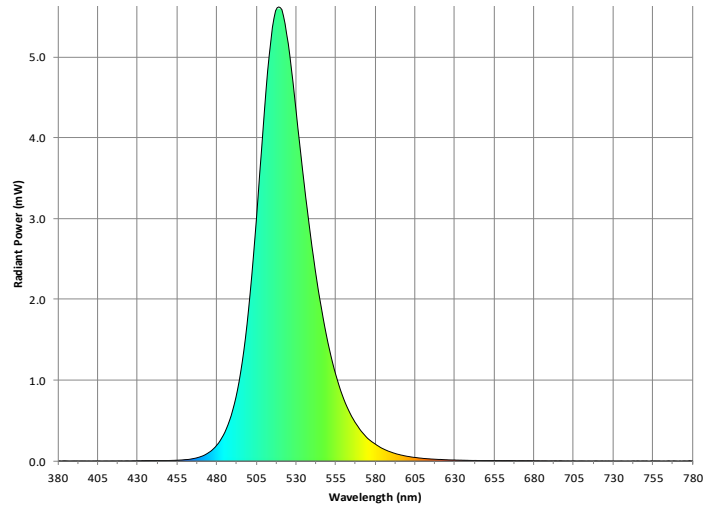

Red
Peak: 635 nm

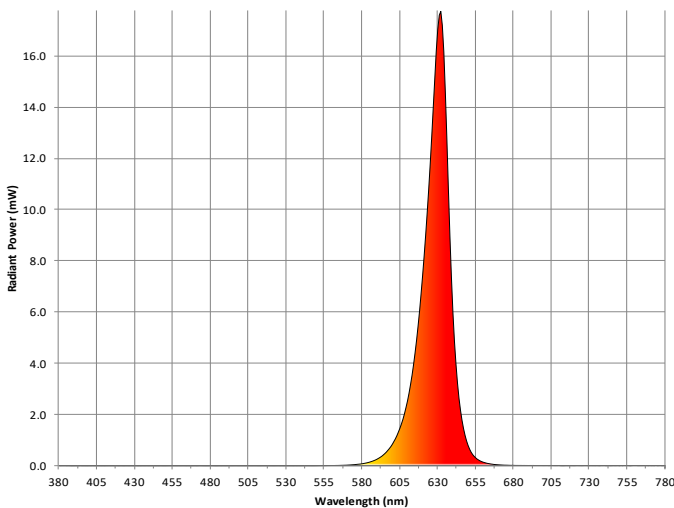

5000K
Cool White

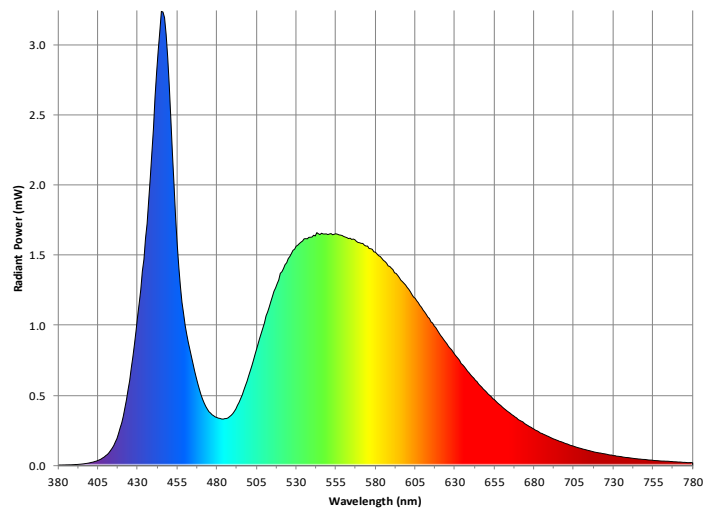

ELECTRICAL CHARACTERISTICS AND PERFORMANCE DATA VERIFIED BY NATIONALLY RECOGNIZED TESTING LABS (NRTL). FOR FULL REPORTS AND RESULTS, VISIT WWW.NORIBACHI.COM/REPORTS. ALL SPECIFICATIONS SUBJECT TO CHANGE WITHOUT NOTICE. ALL VALUES TYPICAL UNLESS OTHERWISE NOTED. LUMEN VALUES MAY VARY BY +/-10%. COLOR TEMPERATURE MAY VARY ACCORDING TO ANSI C78.377. ©2015 - 2016



Lumen Performance

LM-80 Summary

| LED Color | Case Temperature | Drive Current | Reported TM-21 Lifetimes |
|-----------|------------------|---------------|---|
| Red | 85°C | 1000mA | L90(17k) = 68,900 hrs L80(17k) > 103,000 hrs L70(17k) > 103,000 hrs |
| Green | 85°C | 1000mA | L90(9k) = 51,400 hrs L80(9k) > 51,400 hrs L70(9k) > 51,400 hrs |
| Blue | 85°C | 1000mA | L90(9k) = 51,400 hrs L80(9k) > 51,400 hrs L70(9k) > 51,400 hrs |

As Noribachi's drive current is less than 1000mA, the LM-80 data is conservative.

Lumen Multiplier

| Ambient Temperature | Lumen Multiplier |
|---------------------|------------------|
| 10°C | 1.032 |
| 15°C | 1.021 |
| 25°C | 1.000 |
| 40°C | 0.968 |
| 50°C | 0.946 |

Each temperature has an independent initial value. In accordance with IESNA TM021011, Projected Values represent interpolated value based on time durations that are within six times (6X) the IESNA LM-80-08 total test duration (in hours) for the device under testing (DUT) i.e. the packaged LED chip). In accordance with IESNA TM-21-11, Calculated Values represent time durations that exceed six times (6X) the IESNA LM-80-08 total test duration (in hours) for the device under testing (DUT) i.e. the packaged LED chip)

ELECTRICAL CHARACTERISTICS AND PERFORMANCE DATA VERIFIED BY NATIONALLY RECOGNIZED TESTING LABS (NRTL). FOR FULL REPORTS AND RESULTS, VISIT WWW.NORIBACHI.COM/REPORTS. ALL SPECIFICATIONS SUBJECT TO CHANGE WITHOUT NOTICE. ALL VALUES TYPICAL UNLESS OTHERWISE NOTED. LUMEN VALUES MAY VARY BY +/-10%. COLOR TEMPERATURE MAY VARY ACCORDING TO ANSI C78.377. ©2015 - 2016



How to Order

Order Code

| Numbering Order | Specification | Required/Optional | Allowed Values | Description |
|-----------------|-------------------------|-------------------|----------------|--|
| 1 | Fixture | Required | SBM | Shoebox.M |
| 2 | Light Board | Required | HEX | HEX CLU Geometry |
| 3 | Number of CLUs | Required | 126 | For 6 HEX model |
| | | | XXX | Other custom counts possible |
| 4 | LED Color Channels | Required | RGBW | Red, Green, Blue and Cool White |
| | | | XXX | Custom Color Combinations possible* |
| 5 | Voltage | Required | MT | Standard AC input 120VAC – 277VAC |
| | | | HV1 | High Voltage 480VAC option |
| 6 | Connections | Required | HW | Fixtures Hardwired to controller |
| | | | WRLSS | Wireless fixture communication with controller |
| 7 | White Color Temperature | Optional | NW | Neutral White |
| | | | WW | Warm White |
| 8 | Beam Angle | Optional | 40D | 40 degree beam angle option |
| 9 | Surge Protector | Optional | SRG1 | Enhanced surge protector for 120-277VAC |
| | | | SRG2 | Enhanced surge protector for 480 VAC |

* Color Options Red, Green, Blue, White, Amber, Cool/Warm White. Specific temperatures available upon request.

ELECTRICAL CHARACTERISTICS AND PERFORMANCE DATA VERIFIED BY NATIONALLY RECOGNIZED TESTING LABS (NRTL). FOR FULL REPORTS AND RESULTS, VISIT WWW.NORIBACHI.COM/REPORTS. ALL SPECIFICATIONS SUBJECT TO CHANGE WITHOUT NOTICE. ALL VALUES TYPICAL UNLESS OTHERWISE NOTED. LUMEN VALUES MAY VARY BY +/-10%. COLOR TEMPERATURE MAY VARY ACCORDING TO ANSI C78.377. ©2015 - 2016

